

# SHIMANO STEPS

*SHIMANO Total Electric Power System*

---

**Special battery and parts  
user's manual**



# CONTENTS

<b>IMPORTANT NOTICE .....</b>	<b>3</b>
<b>GENERAL SAFETY INFORMATION .....</b>	<b>3</b>
<b>NOTICE .....</b>	<b>5</b>
<b>Introduction .....</b>	<b>6</b>
<b>Items for regular inspection before riding the bicycle .....</b>	<b>6</b>
<b>Handling method .....</b>	<b>6</b>
Charging time.....	6
Battery storage method .....	6
Battery life .....	6
Used batteries.....	6
<b>Booklet Structure .....</b>	<b>8</b>
<b>Names of parts.....</b>	<b>9</b>
<b>Main specifications .....</b>	<b>10</b>
Battery.....	10
Battery charger .....	10
<b>Charging the battery.....</b>	<b>11</b>
Designated charging time .....	11
Charging the battery removed from the bicycle.....	11
BT-E6000 / BT-E6001 / BT-E6010 / BT-E8035 / BT-E8035-L / BT-E8036 .....	11
BT-E8010 / BT-E8014 / BT-E8016 / BT-E8020.....	13
Charging the battery attached to the bicycle.....	14
Charger LED lamp .....	16
Battery LED lamp .....	17
Display while charging.....	17
Battery level display.....	18
Proper use of the battery.....	19
<b>Installing the battery .....</b>	<b>19</b>
Rear carrier mount type .....	20
BT-E6000 / BT-E6001 .....	20
External mount type .....	20
BT-E6010 / BT-E8010 / BT-E8014 / BT-E8016.....	20

Integrated mount type .....	21
BT-E8020 .....	21
BT-E8035 / BT-E8035-L / BT-E8036.....	22
<b>Removing the battery .....</b>	<b>22</b>
Rear carrier mount type .....	22
BT-E6000 / BT-E6001 .....	22
External mount type .....	23
BT-E6010 / BT-E8010 / BT-E8014 / BT-E8016.....	23
Integrated mount type .....	24
BT-E8020 .....	24
BT-E8035 / BT-E8035-L / BT-E8036.....	26
<b>Power ON/OFF .....</b>	<b>28</b>
Turning the power ON from the cycle computer.....	28
Turning the power ON from the satellite system on/off switch .....	28
Turning the power ON from the battery .....	29
<b>TROUBLESHOOTING .....</b>	<b>30</b>
When a problem occurs.....	30
Battery LED lamp error indication .....	32
When there are five battery LED lamps.....	32
When there is one battery LED lamp .....	33

## IMPORTANT NOTICE

- Contact the place of purchase or a bicycle dealer for information on installation and adjustment of the products which are not found in the user's manual. The dealer's manual for professional bicycle mechanics is available from our website (<https://si.shimano.com>).
- Do not disassemble or modify the product.
- Please observe the appropriate rules and regulations of the country, state or region in which you conduct your business as a dealer.
- Also, read the SHIMANO STEPS user's manual.

 **For safety, be sure to read this "user's manual" thoroughly before use, follow it for correct use, and store it so that it can be referenced at any time.**

The following instructions must be observed at all times in order to prevent personal injury and physical damage to equipment and surroundings. The instructions are classified according to the degree of danger or damage which may occur if the product is used incorrectly.

### DANGER

Failure to follow the instructions will result in death or serious injury.

### WARNING

Failure to follow the instructions could result in death or serious injury.

### CAUTION

Failure to follow the instructions could cause personal injury or physical damage to equipment and surroundings.

## GENERAL SAFETY INFORMATION





**For information on the replacement procedure, contact the place of purchase or distributor.**



**Be sure to observe the following instructions in order to avoid burns or other injury from fluid leakage, overheating, fire, or explosion.**

## DANGER

### Handling the battery

- Use the specified battery charger for charging and observe the specified charging conditions. Doing otherwise may cause overheating, bursting, or ignition.
- Do not leave the battery near sources of heat such as heaters. Doing so may cause it to burst or ignite.
- Do not heat the battery or throw it into a fire. Doing so may cause it to burst or ignite. 
- Do not deform, modify, disassemble or apply solder directly to the battery. Doing so may cause it to leak, overheat, burst, or ignite. 
- Do not connect the terminals with metallic objects. Doing so may cause them to short circuit or overheat, and result in burns or injury.
- Do not carry or store the battery together with metallic objects such as necklaces or hairpins. Doing so may cause it to short circuit or overheat, and result in burns or injury.
- Do not place the battery into fresh water or sea water, and do not allow the battery terminals to get wet. Doing so may cause overheating, bursting, or ignition.
- Do not throw or subject the battery to strong shock. Doing so may cause overheating, bursting, or ignition.

### Handling the battery charger

- Do not allow the battery charger to get wet. If it is wet or water is allowed inside, it could cause a fire, ignition, overheating, or electric shock.
- Do not use it while it is wet, and do not touch or hold it with wet hands. An electric shock may occur.
- Do not cover the battery charger with a cloth while it is in use. Doing otherwise may cause the heat to build up and the case may become deformed, or fire, ignition, or overheating may occur.
- Do not disassemble or modify the battery charger. If this is not observed, electric shocks or injury may occur.
- Use the battery charger at the specified power supply voltage only. If a power supply voltage other than that specified is used, fire, explosions, smoke, overheating, electric shocks or burns may occur.
- Use the specified battery and charger combination for charging and observe the specified charging conditions. Doing otherwise may cause overheating, bursting, or ignition.

## **WARNING**

- Do not insert or remove the plug while it is wet. Doing so may result in electric shock. If there is water leaking out of the plug, dry it thoroughly before inserting it. 
- Do not recharge the battery in wet or very humid places. (EC-E8004)  
Do not recharge the battery in wet or very humid places, or outdoors. (Battery charger other than the EC-E8004)  
A fire, ignition, overheating, or electric shock may occur.
- If the battery does not become fully charged after two hours of charging, immediately unplug the battery from the electrical outlet and contact the place of purchase. Doing otherwise may cause overheating, bursting, or ignition.  
Refer to "Designated charging time."

## **Handling the battery**

- If any liquid leaking from the battery gets into your eyes, immediately wash the affected area thoroughly with clean water such as tap water without rubbing your eyes, and seek medical advice immediately. If this is not done, the battery liquid may damage your eyes.
- Do not use it outside of the operating temperature range of the battery.  
If the battery is used or stored in temperatures which are outside these ranges, fire, damage to the battery or problems with operation may occur.
  1. During discharge: -10°C - 50°C
  2. During charging: 0°C - 40°C
- Do not use the battery if it has any noticeable scratches or other external damage. If this is not observed, bursting, overheating or problems with operation may occur.
- Do not use the battery if leakages, discoloration, deformation or any other abnormalities occur. If this is not observed, bursting, overheating or problems with operation may occur.

## **Handling the battery charger**

- Hold the power plug when connecting or disconnecting the plug. Failure to do so may cause a fire or electric shock. If the following occurs, stop using the device and contact your place of purchase. A fire or electric shock may occur.
  - \* If heat or acrid-smelling smoke is coming out from the power plug.
  - \* There is a bad connection inside the power plug.
- Do not touch metallic parts of the power plug or the AC adapter if there is a lightning storm. If lightning strikes, electric shocks may occur.

- Do not overload the electrical outlet with appliances beyond its rated capacity, and use only a 100 - 240 V AC electrical outlet. If the electrical outlet is overloaded by connecting too many appliances using adapters, overheating resulting in fire may occur.
- Do not damage the power cord or power plug. (Do not damage, modify, let near hot objects, bend, twist or pull them; do not place heavy objects on top or bundle them tightly.) If they are used while damaged, fire, electric shocks or short-circuits may occur.
- Do not use the battery charger with commercially-available electrical transformers designed for overseas use (travel converters).  
They may damage the battery charger.
- Always be sure to insert the power plug as far as it will go. If this is not observed, fire may occur.
- When charging the battery while it is installed on the bicycle, do not move the bicycle.  
The battery charger's power plug may come loose and not be fully inserted into the electrical outlet, resulting in risk of fire.

## **CAUTION**

## **Handling the battery**

- Do not leave the battery in a place exposed to direct sunlight, inside a vehicle on a hot day, or other hot places. This may result in battery leakage.
- If any leaked fluid gets on your skin or clothes, wash it off immediately with clean water. The leaked fluid may damage your skin.
- Keep away from children.
- Handle components with both hands. Failure to do so may cause the components to fall and break or cause injury.
- If an error occurs during the battery discharge or charge operation, immediately stop using it and check the user's manual. If you are not sure, consult the place of purchase or distributor.
- Avoid touching the battery for an extended period of time when it is at a high temperature. Doing so may cause a low-temperature burn. Riding with a high level of assistance on hot days or charging the battery in direct sunlight may cause the surface temperature of the battery to exceed 60°C (BT-E8036). 

## **Handling the battery charger**

- When performing cleaning, disconnect the power plug from the electrical outlet and the charging plug from the battery. If this is not observed an electric shock may occur.

- Do not let the battery touch the same area of skin for an extended period of time while it is charging. The temperature of components may reach 40 to 70°C, which can cause low-temperature burns.



- Periodically check the battery charger and adapter, particularly the cord, plug, and case, for any damage. If the charger or adapter is broken, do not use it until it has been repaired by the place of purchase or distributor.
- Use the product under the supervision of someone responsible for safety and upon receiving usage instructions. Do not allow physically, sensory, or mentally impaired persons, inexperienced persons, or persons with no required knowledge, including children, to use the product. Do not allow children to play near the product.

## NOTICE

**Charging can be carried out at any time, regardless of the remaining battery, but please fully charge the battery in the following cases:**

- The battery cannot be used at the time of purchase. Before riding, be sure to fully charge the battery.

If the battery has become completely empty, charge it as soon as possible. If you leave the battery without charging it, the battery will deteriorate and may become unable to be used.

## Handling the battery

- If the screen of the cycle computer is not displayed, fully charge the battery. The battery level may affect the display.
- If the LED display of the battery does not turn on even when the battery power switch is pressed, the protection circuit may have activated. Connect the battery charger to deactivate the protection circuit.
- If the battery is charged in a low-temperature environment of 5°C or lower, the traveling distance of a full charge will be shorter. Also, if the battery is used in a low-temperature environment of 5°C or lower, the battery consumption will become quicker. This is due to the characteristics of the battery, and the battery will return to normal when at a normal temperature.
- Riding with a high level of assistance in a low-temperature environment when the battery level is low may cause the battery level to drop to 0%, due to the characteristics of the battery. Charge it before use.

## Handling the battery charger

- The battery can be charged at temperatures between 0°C and 40°C. The battery charger will not operate at temperatures outside the range. It will display an error. (The battery charger LED lamp flashes.)  
Do not use in environments with high humidity. (EC-E8004)
- Do not use outdoors or in environments with high humidity. (Battery charger other than the EC-E8004)  
Charge the battery in a location not exposed to rain or wind. (EC-E8004)
- Charge the battery indoors to avoid exposure to rain or wind. (Battery charger other than the EC-E8004)
- Do not place the battery charger on dusty floors when using it.
- Place the battery charger on a stable surface such as a table when using it.
- Do not place any objects on top of the battery charger or its cable. Also do not cover them with a cloth or other material.
- Do not bundle the cables.
- Do not hold the battery charger by the cables when carrying it.
- Do not apply excessive tension to the cable and charging plug.
- In order to prevent the cable from being damaged, avoid wrapping it around the main body during storage.
- Do not wash the battery charger or wipe it using detergents.
- Do not allow children to play near the product.
- When charging with the battery installed to a bicycle, take care that your legs, etc. do not get caught in the battery charger cord. Doing so may cause injury or cause the bicycle to fall over and break the components.
- When charging the battery while it is mounted on the bicycle, be careful of the following:
  - Before charging, check that there is no water on the charging port of the charging plug.
  - Check that the battery mount is locked before charging.
  - Do not remove the battery from the battery mount while charging.
  - Do not ride with the charger mounted.
  - Close the cap on the charging port when not charging.
  - Fix the bicycle in place when charging, so that it does not tip over.
- Make sure to close the charging port cap after charging. If foreign matter such as dirt or dust adheres to the charging port, there is a risk that the charging plug will not fit into the charging port.

- Using the battery outside the operating temperature range may cause problems with operation or performance degradation.
- The charging time is longer when the battery temperature is high.

## Care and maintenance

- The number written on the key of the battery mount is necessary when purchasing a spare key. Store it carefully.
- Do not use thinner or other solvents to clean any of the components. Doing so may damage their surface.
- When there is dirt on the terminals of the battery mount and battery charger, remove the battery, remove the power plug from the electrical outlet, and then clean them with a clean rag or cotton bud dampened with ethanol, etc. If you repeatedly install and remove the battery while they are still dirty, it may cause wear on the terminals and make them unable to be used.

### Terminal example

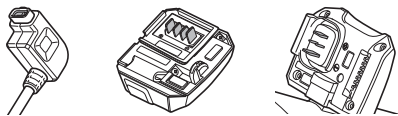

- Keep the surface where the battery contacts the battery mount clean. If the battery is connected with foreign material such as dirt or dust attached, the battery may become unable to be removed.



- Use a damp, well wrung out cloth when cleaning the battery and plastic cover.
- If you have any questions about the use and maintenance of the product, consult the place of purchase.
- Products are not guaranteed against natural wear and deterioration from normal use and aging.
- For maximum performance we highly recommend SHIMANO lubricants and maintenance products.

## Introduction

You cannot use the battery immediately after shipment. The battery can be used after fully charging it with the designated battery charger. Be sure to charge it before use. The battery can be used when the LED on it turns on.

## Items for regular inspection before riding the bicycle

Inspect the following items before riding the bicycle. If any problems are found, consult the place of purchase or distributor.

- Is the battery level sufficient?
- Is the battery installed correctly?

## Handling method

### ■ Charging time

The charging time will vary depending on the battery level and the battery charger being used. Refer to "Designated charging time."

This is a lithium-ion battery. Use the dedicated battery charger designated by SHIMANO.

### ■ Battery storage method

- If the bicycle will not be ridden for an extended period, store it with a battery level of approximately 70%. Also, charge the battery once every six months to ensure that it is not completely discharged.
- Store the battery or bicycle with battery installed in a cool indoor location away from direct sunlight and rain (estimate: 10 to 20°C). If the storage temperature is low or high, the performance of the battery is reduced, and its useable time will be shorter. When you use the battery after a long storage period, make sure to charge it first.

### ■ Battery life

- The battery is an exhaustible item. The battery will gradually lose its capacity to charging after repeated use. If the length of time that the battery can be used and its traveling distance become extremely short, it has probably reached the end of its life, and so you will need to purchase a new battery.
- The life of the battery will vary depending on factors such as the storage method, the usage conditions, the surrounding environment and the characteristics of the individual battery pack.

### ■ Used batteries

Lithium-ion batteries are recyclable, valuable resources.

Please observe the appropriate rules of the country, state or region regarding the disposal of used batteries. If you are not sure, consult the place of purchase or distributor.



## Disposal information for countries outside the European Union



This symbol is only valid within the European Union. Follow local regulations when disposing of used batteries. If you are not sure, consult the place of purchase or a bicycle dealer.

## FCC compliance information

This device complies with Part 15 of the FCC Rules.

Operation is subject to the following two conditions:

- (1) This device may not cause harmful interference, and
- (2) This device must accept any interference received, including interference that may cause undesired operation.

NOTICE: This equipment has been tested and found to comply with the limits for a Class B digital device, pursuant to Part 15 of the FCC Rules. These limits are designed to provide reasonable protection against harmful interference in a residential installation. This equipment generates, uses and can radiate radio frequency energy and, if not installed and used in accordance with the instructions, may cause harmful interference to radio communications. However, there is no guarantee that interference will not occur in a particular installation. If this equipment does cause harmful interference to radio or television reception, which can be determined by turning the equipment off and on, the user is encouraged to try to correct the interference by one or more of the following measures:

- Reorient or relocate the receiving antenna.
- Increase the separation between the equipment and receiver.
- Connect the equipment into an outlet on a circuit different from that to which the receiver is connected.
- Consult the dealer or an experienced radio/TV technician for help.

## Booklet Structure

### **SHIMANO STEPS user's manuals are split among several booklets, as described below.**

Be sure to read these user's manuals thoroughly before use, and follow them for correct use. Store the user's manuals so that they can be referenced at any time.

The latest user's manuals are available on our website (<https://si.shimano.com>).

- **SHIMANO STEPS user's manual**

This is the basic user's manual for SHIMANO STEPS. It contains the following content.

- SHIMANO STEPS quick guide
- How to operate assist bicycles that use flat handlebars, such as city, trekking, or MTB type bicycles
- Troubleshooting

- **SHIMANO STEPS user's manual for drop handlebar bicycles (separate booklet)**

This booklet describes how to operate assist bicycles that use a drop handlebar and are controlled using a dual control lever. This should be read along with the SHIMANO STEPS user's manual.

- **SHIMANO STEPS special battery and parts user's manual (this document)**

It contains the following content.

- How to charge and handle the SHIMANO STEPS special battery
- How to attach and remove the SHIMANO STEPS special battery to the bicycle
- How to use the satellite system on/off switch and satellite charging port
- How to read the battery LEDs when charging or during an error, and how to handle errors

- **SHIMANO STEPS cycle computer user's manual**

It contains details on the SHIMANO STEPS cycle computer. Refer to it for how to view the display and how to configure the settings.

- **Switch unit user's manual**

This is the assist switch and shifting switch user's manual. It describes switch unit operations.

# Names of parts

## EC-E6000

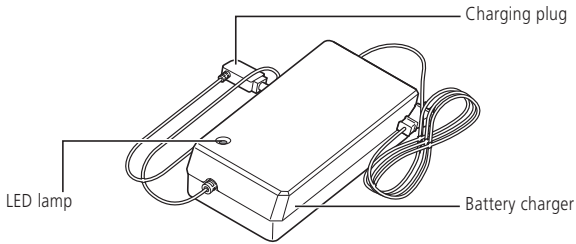

## EC-E6002

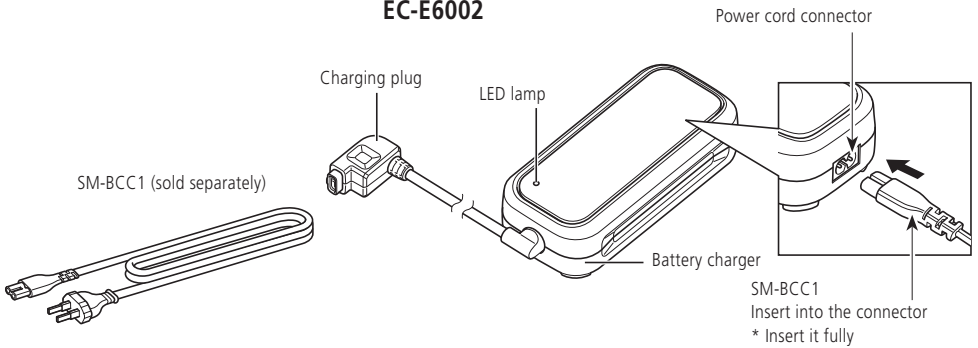

## EW-CP100 \*1

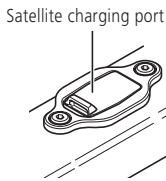

## EC-E8004

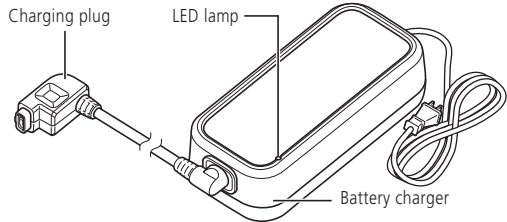

## EW-SW100 / EW-SW300 \*1

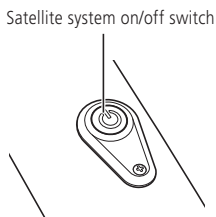

## Adapter (sold separately)

SM-BTE60



SM-BTE80



\*1 The installation position differs depending on the bicycle.

## Main specifications

### Battery

Battery main body	Lithium-ion
Nominal capacity	BT-E6000 / BT-E6001 / BT-E6010 / BT-E8014: 11.6 Ah BT-E6001 / BT-E8010 / BT-E8020 / BT-E8035 / BT-E8035-L: 14 Ah BT-E8016 / BT-E8036: 17.5 Ah
Operating temperature range	During discharge: -10°C - 50°C During charging: 0°C - 40°C
Nominal voltage	36 V

- Depending on the drive unit, some batteries may be incompatible. For details, refer to the SHIMANO product website (<https://productinfo.shimano.com/>).
- The drive unit may not operate correctly if the latest firmware version is not installed. Connect to E-TUBE PROJECT, then update the firmware.

### Battery charger

Input	EC-E6000: 100 - 240 V AC, 2.5 A, 50/60 Hz EC-E6002: 100 - 240 V AC, 1.5 A, 50/60 Hz EC-E8004 (USA/CANADA): 120 V AC, 1.6 A, 60 Hz EC-E8004 (Others): 100 - 240 V AC, 1.9 - 0.9 A, 50/60 Hz
Output	EC-E6000: 40 V DC, 4.4 A/42 V DC, 4 A EC-E6002: 42 V DC, 1.8 A EC-E8004 (USA/CANADA): 42 V DC, 4 A EC-E8004 (Others): 42 V DC, 4 - 4.6 A (INPUT: 100 - 240 V AC)
Compatible batteries *	SHIMANO BT-E6000, BT-E6001, BT-E6010, BT-E8010, BT-E8014, BT-E8016, BT-E8020, BT-E8035, BT-E8035-L, BT-E8036

\* Includes batteries that may not be available in your region.

## Charging the battery

### ■ Designated charging time

Battery	Charging time from a battery level of 0%			
	EC-E6000	EC-E6002	EC-E8004	
			100 - 127 V AC	220 - 240 V AC
BT-E6000, BT-E6010, BT-E8014	About 4 hours	About 6 hours 30 minutes	About 3 hours 30 minutes	About 3 hours
BT-E6001, BT-E8010, BT-E8020, BT-E8035, BT-E8035-L	About 5 hours	About 7 hours 30 minutes	About 4 hours 30 minutes	About 4 hours
BT-E8016, BT-E8036	About 5 hours 30 minutes	About 10 hours 12 minutes	About 5 hours 40 minutes	About 4 hours 48 minutes

### ■ Charging the battery removed from the bicycle

Charge the battery placed on a level surface.

Orient the battery and the battery charger as indicated in the figure.

\* The orientation of the battery charging port differs according to the model.

**BT-E6000 / BT-E6001 / BT-E6010 / BT-E8035 / BT-E8035-L / BT-E8036**

1. Attach the adapter to the battery charger's charging plug.
2. Connect the battery charger's power plug to the electrical outlet.
3. Connect the adapter into the charging port.

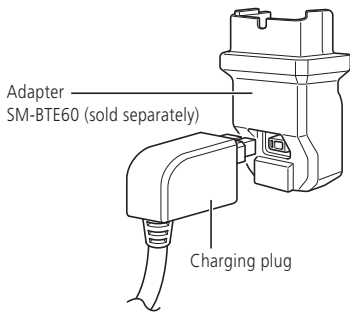

### BT-E6000 / BT-E6001

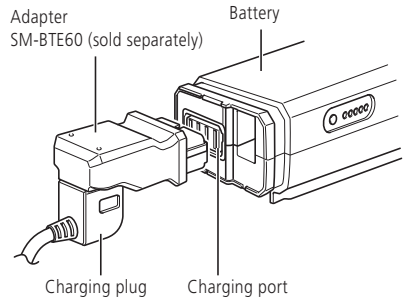

### BT-E6010

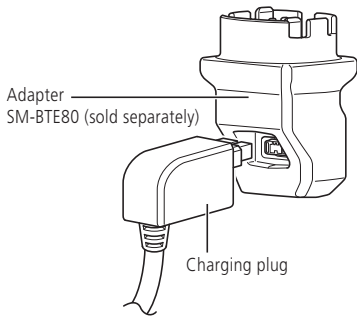
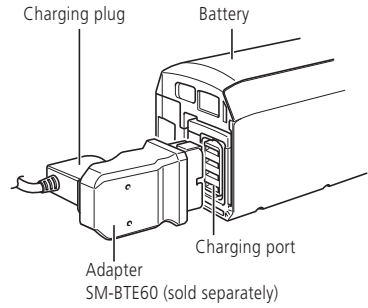

### BT-E8035 / BT-E8035-L / BT-E8036

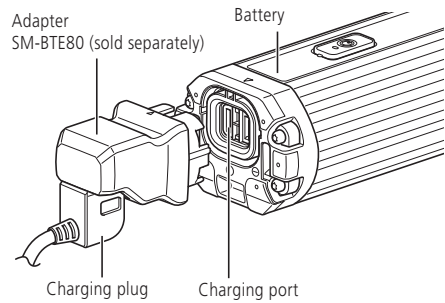

1. Connect the battery charger's power plug to the electrical outlet.
2. Insert the charging plug into the battery's charging port.

**BT-E8010 / BT-E8014 / BT-E8016**

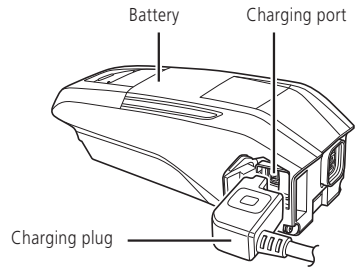

**BT-E8020**

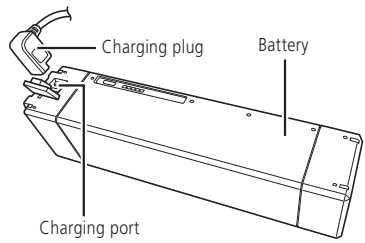

## ■ Charging the battery attached to the bicycle

Charge the battery with the battery charger placed on the floor or some other stable surface. Fix the bicycle in place when charging, so that it does not tip over.

1. Connect the battery charger's power plug to the electrical outlet.
2. Insert the charging plug into the charging port on the battery mount or battery.

**BT-E6000 / BT-E6001**

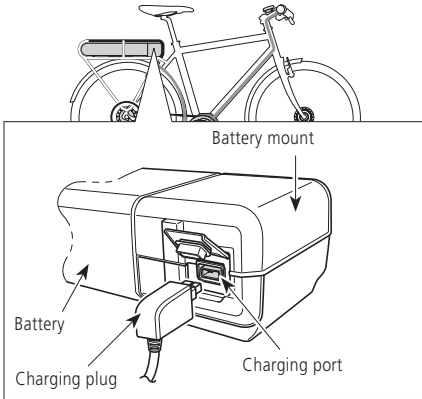

**BT-E8020**

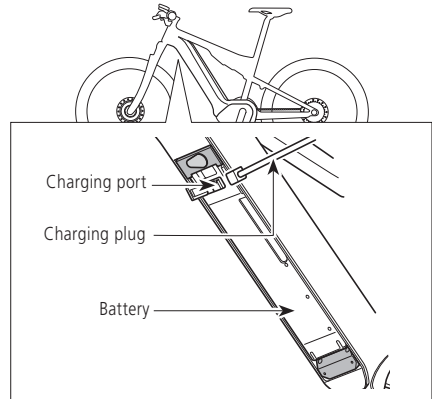

**BT-E6010**

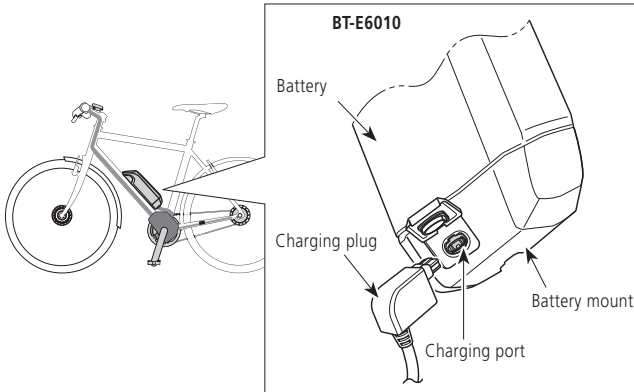

**BT-E8010 / BT-E8014 / BT-E8016**

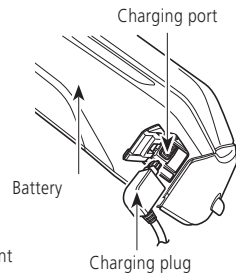

**BT-E8035 / BT-E8035-L / BT-E8036**

- The position of the satellite charging port differs depending on the bicycle.

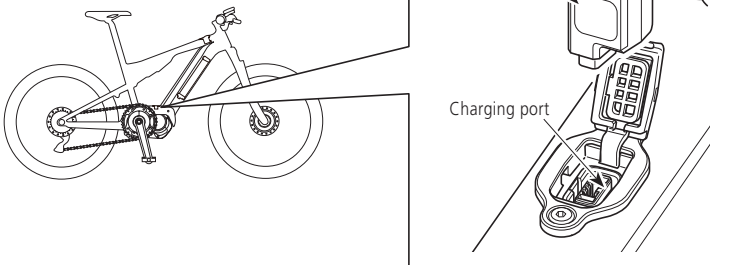



**3.** After charging, firmly close the charging port cap.

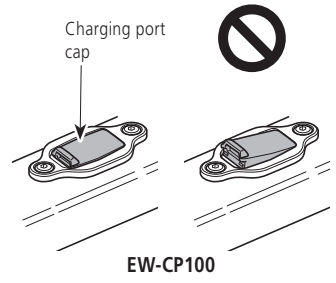
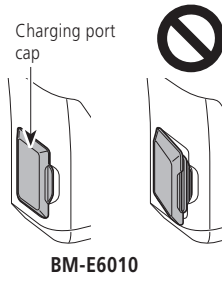
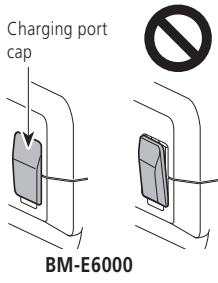

## ■ Charger LED lamp

After charging has started, the LED lamp on the battery charger lights up.

● <b>Lit up</b>	Charging
⚡ <b>Flashing</b>	Charge error
● <b>Off</b>	<ul style="list-style-type: none"><li>• Battery disconnected</li><li>• 1 hour or more after finishing charging</li><li>• 1 hour or more after an error occurs</li></ul>

### NOTICE

The charger LED lamp does not turn off immediately after charging is complete. Check the charging status using the LED lamp on the battery.

EC-E6000

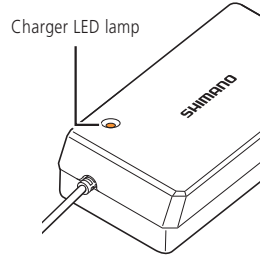

EC-E6002

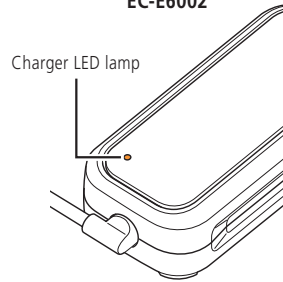

EC-E8004

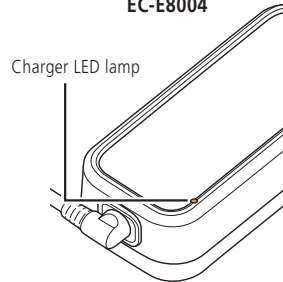

## ■ Battery LED lamp

The LED lamp on the battery enables the current charging status and battery level to be checked. The shape of the LED differs depending on the model.

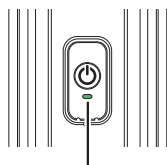

Battery LED lamp



Battery LED lamp

### Display while charging

#### When there are five battery LED lamps

Lighting pattern*1	Charging status
	0 - 20%
	21 - 40%
	41 - 60%
	61 - 80%
	81 - 99%
	100%

\*1 : Off : Lights up : Flashes

#### When there is one battery LED lamp

Lighting pattern*1	Charging status
(Repeatedly flashes green 1 time)	0 - 20%
(Repeatedly flashes green 2 time)	21 - 40%
(Repeatedly flashes green 3 time)	41 - 60%
(Repeatedly flashes green 4 time)	61 - 80%
(Repeatedly flashes green 5 time)	81 - 99%
/	100%*2







\*1 : Off : Lights up : Flashes

\*2 Turns off one hour after fully charged.

## Battery level display

You can press the power switch to check the current battery level.







### When there are five battery LED lamps

Lighting pattern*1	Battery level
	100 - 81%
	80 - 61%
	60 - 41%
	40 - 21%
	20 - 1%
	0% * If the battery is not attached to the bicycle
	0% * If the battery is attached to the bicycle * If the power is OFF

\*1  : Off  : Lights up  : Flashes

### When there is one battery LED lamp

- The LED lights up when the battery is attached to the bicycle. (Unless the battery level is at 0%)

Lighting pattern*1	Battery level
 (Repeatedly flashes green 5 time)	100 - 81%
 (Repeatedly flashes green 4 time)	80 - 61%
 (Repeatedly flashes green 3 time)	60 - 41%
 (Repeatedly flashes green 2 time)	40 - 21%
 (Repeatedly flashes green 1 time)	20 - 0%
	0% (if the battery is attached to the bicycle)

\*1  : Off  : Flashing



When the battery level is low, system functions will be shut off in the following order.

- Electronic assist (The assist mode stops after automatically switching to [ECO]. If the battery-powered light is connected, the mode will switch to [ECO] earlier.)
- Electronic gear shifting
- Light

## Proper use of the battery

**Charging can be carried out at any time, regardless of the remaining battery, but please fully charge the battery in the following cases: Be sure to use the dedicated battery charger.**

- The battery cannot be used at the time of purchase. Before riding, be sure to fully charge the battery.

**If the battery has become completely empty, charge it as soon as possible. If you leave the battery without charging it, it will cause the battery to deteriorate.**

- If the bicycle will not be ridden for a long period, store with the battery level around 70%. Also, make sure to charge the battery every six months to ensure that it does not completely discharge.

## Installing the battery

The battery is secured to the battery mount with a key. There are several types of keys, so there may be differences with this explanation.

- The battery can be inserted without turning the key.
- For details on the compatibility of the battery and battery mount, check the SHIMANO product website (<https://productinfo.shimano.com>).



### CAUTION

- Firmly hold the battery during installation, being careful not to drop it. Failure to do so may cause the components to fall and break or cause injury.
- Keep the following in mind to prevent the battery from dropping while riding.
  - Confirm that the battery is securely locked to the battery mount.
  - Do not ride with the key inserted.

### NOTICE

Check that the charging port cap is closed before riding the bicycle.

## ■ Rear carrier mount type

### BT-E6000 / BT-E6001

1. Insert the battery into the rail from the rear of the bicycle.
  - Slide the battery to the front and push it in firmly.

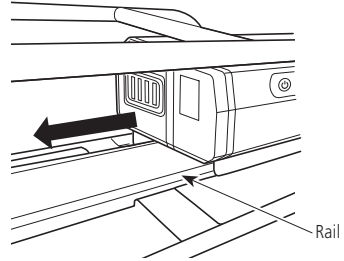

## ■ External mount type

### BT-E6010 / BT-E8010 / BT-E8014 / BT-E8016

1. Insert the battery from below.
  - Align the concave section on the bottom of the battery with the convex section on the battery mount, and then insert the battery.

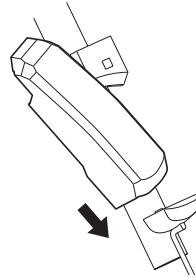

2. Slide the battery.
  - Insert the battery until you hear a click.



## ■ Integrated mount type

The following procedure uses a type of bicycle where the battery is installed/removed from the lower side of the down tube as an example.

### BT-E8020

- 1.** Use the following procedure to insert from the lower side of the battery.
  - (1) Insert from the lower side of the battery.
  - (2) Slide the battery. Push it in firmly until you hear it click into place.

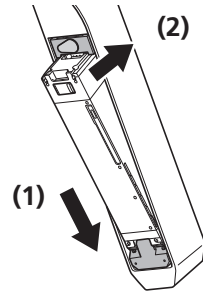

### NOTICE

Do not install or remove the battery with the key inserted or the keyhole cap left open. The battery could make contact with the handle on the key or the keyhole cap, damaging it.

1. Use the following procedure to insert from the lower side of the battery.
  - (1) Insert from the lower side of the battery.
  - (2) Slide the battery. Push it in firmly until you hear it click into place.

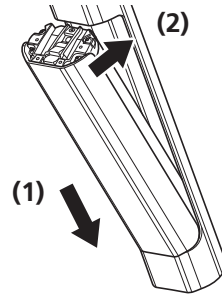

**NOTICE**

- After pushing the battery in, pull the battery to confirm that it is locked securely.

**Removing the battery**

**CAUTION**

- Firmly hold the battery during removal or transport, being careful not to drop it. Failure to do so may cause the components to fall and break or cause injury.

**■ Rear carrier mount type**

1. Insert the key to release the lock.
  - (1) Press the power switch to turn the power OFF, and then insert the key into the key cylinder on the battery mount.
  - (2) Turn the key until you feel it make contact.

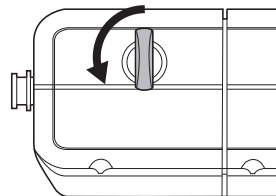
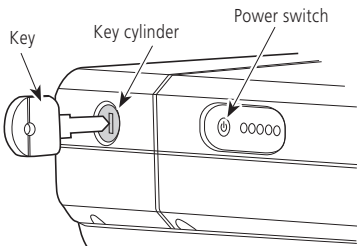

2. Remove the battery.

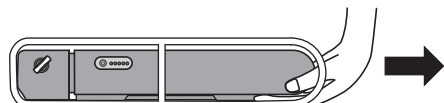



## External mount type

BT-E6010 / BT-E8010 / BT-E8014 / BT-E8016

### 1. Insert the key.

Press the power switch to turn the power OFF, and then insert the key into the key cylinder on the battery mount.

#### BT-E6010

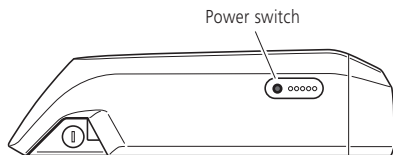

#### BT-E8010 / BT-E8014 / BT-E8016

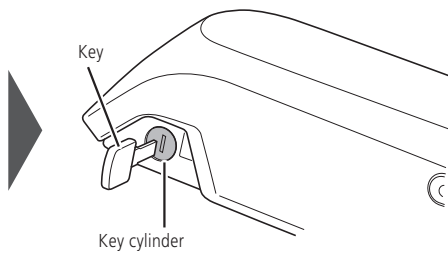
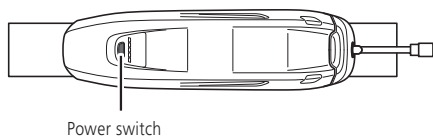

### 2. Release the battery lock.

Turn the key until you feel it make contact.

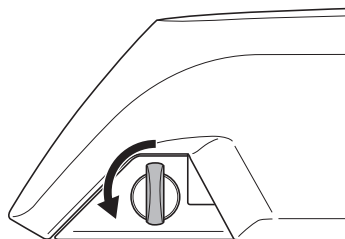

### 3. Remove the battery.

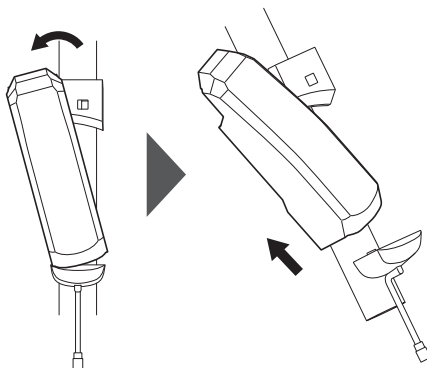

## ■ Integrated mount type

If a battery cover from another company is installed, remove the battery cover first. The following procedure uses a type of bicycle where the battery is installed/removed from the lower side of the down tube as an example.

### BT-E8020

#### 1. Open the keyhole cap.

Press the power switch to turn the power OFF, and then open the keyhole cap.

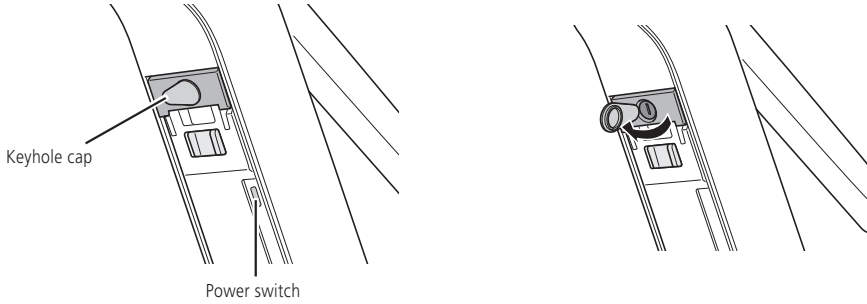

#### 2. Release the battery lock.

(1) Insert the key into the key cylinder of the battery mount.

(2) Turn the key clockwise.

(3) Push the key in.

The battery is unlocked.

(1)

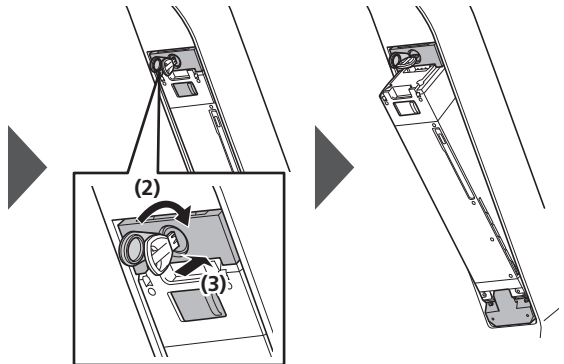
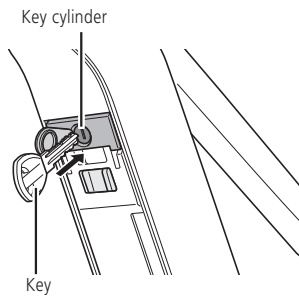

**3.** Remove the battery.

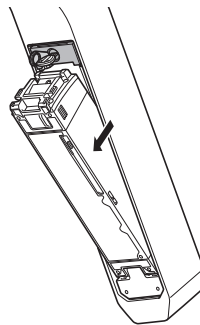

**1.** Turn the power OFF.

If there is a keyhole cap, open it.

\* The position and operation of the power switch differ depending on the bicycle.

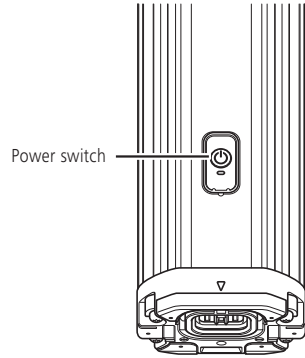

**2.** Release the battery lock.

(1) Insert the key into the key cylinder of the battery mount.

(2) Support the battery with your hand, and turn the key clockwise.

The battery is unlocked. The double latch plate retains the battery in the designated position and prevents it from falling out.

If the battery does not go down into the designated position, pull out the battery with your hand while turning the key.

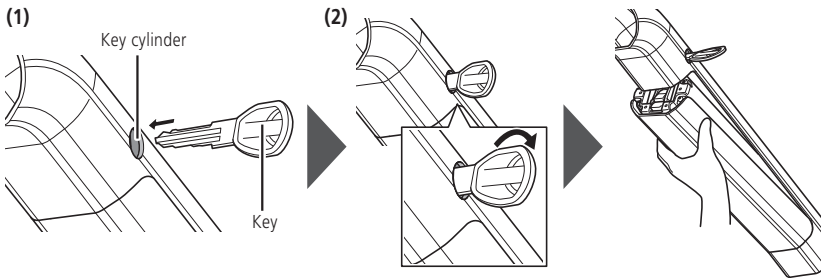

**NOTICE**

- If the battery is retained with a double latch plate, the double latch plate could deform if struck by a strong external force, causing the battery to drop.
- A hexagon wrench may be used instead of a key, depending on the model. Unlock by turning it 90° clockwise, as shown in the figure. Do not forcibly turn it counterclockwise, or turn it more than 90° clockwise. Doing so may damage it.

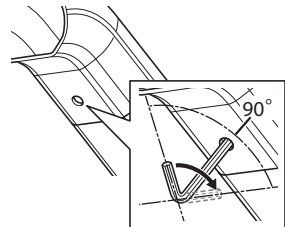

- 3.** Remove the battery.  
Remove the battery while supporting it with your hand and pushing the double latch plate.

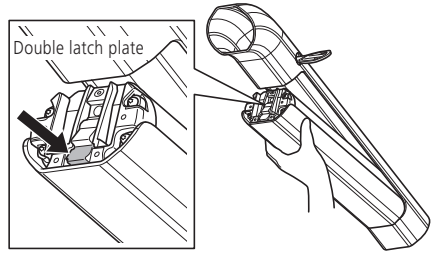

## Power ON/OFF

- The power cannot be turned ON while charging.
- When the bicycle has been stopped for 10 minutes, the auto power OFF function automatically switches the power OFF.

### NOTICE

- Check the following prior to turning the power ON.
  - The battery is firmly attached to the battery mount.
  - The cycle computer is firmly attached to the bracket (refer to the "SHIMANO STEPS cycle computer user's manual").
- Do not step on the pedal when turning the power ON/OFF. Doing so may cause a system error.
- The built-in battery of the satellite system on/off switch / cycle computer is charged while the system is running. If the charge is insufficient because of long-term storage, etc., charge the built-in battery using one of the methods below. It takes a maximum of two hours to charge the built-in battery.
  - Charge the (main) battery while it is mounted on the bicycle. (BM-E6000 / BM-E6010 / EW-CP100 only)
    - \* When the (main) battery is fully charged, charging of the built-in battery also stops automatically.
  - The power can be turned ON using the power button of the (main) battery.
    - \* The power automatically turns OFF if the bicycle is stopped for 10 minutes. When charging for more than 10 minutes, operate any switch on the bicycle or turn the crank to keep the system running.
  - Charging can be carried out by connecting the satellite system on/off switch / cycle computer to the PC version of E-TUBE PROJECT. Make a request to the place of purchase.

### ■ Turning the power ON from the cycle computer

The power button is not equipped, depending on the model of the cycle computer. Use another method to turn the power ON.

#### 1. Press the power switch.

The button may need to be held down, depending on the model of the cycle computer. Hold down the button until the screen turns on.

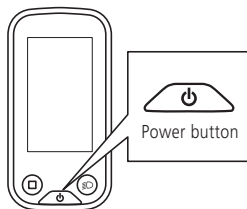

### ■ Turning the power ON from the satellite system on/off switch

The position of the satellite system on/off switch differs depending on the bicycle.

#### 1. Press and hold the power button for 0.5 seconds.

- The LED turns on for a short period of time. If the power is turned ON normally, the LED will light up for several seconds.
- The LED flashes twice when turning the power ON, if the built-in battery capacity of the satellite system on/off switch has decreased. The built-in battery will be charged if you leave the power ON for a little while.

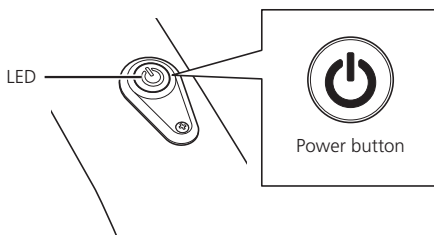

## ■ Turning the power ON from the battery

1. Press the battery power switch.

The LED lamp turns on and the battery level is indicated.

### BT-E6000 / BT-E6001

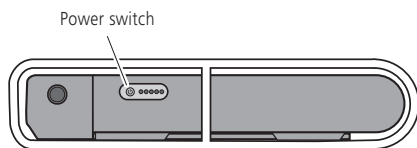

### BT-E8010 / BT-E8014 / BT-E8016

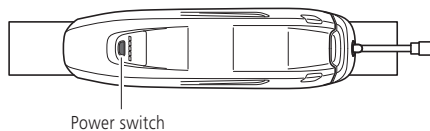

### BT-E6010

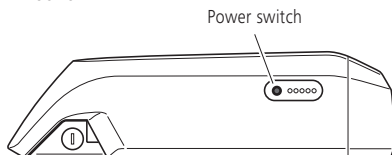

### BT-E8020

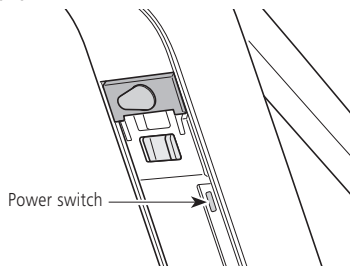

### BT-E8035 / BT-E8035-L / BT-E8036

- The position of the power switch differs depending on the bicycle.

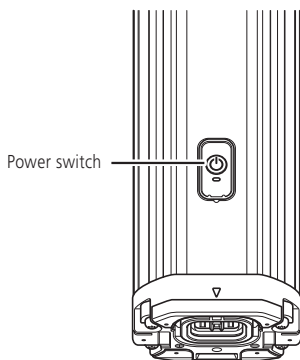

Pressing the battery power switch for approximately six seconds will force the power OFF for emergencies. (excluding the BT-E6000 / BT-E6001 / BT-E6010).

## TROUBLESHOOTING

### ■ When a problem occurs

Symptoms	Causes/possibilities	Remedies
The battery LED does not light up.	Has the battery level been left at 0% for an extended period of time? Or, have you not charged the battery after purchase?	Charge the battery. If the LED does not light up after charging the battery, contact the place of purchase.
The battery depletes quickly.	The battery may have reached the end of its life.	Replace the battery with a new one.
	There is a risk that the battery's temperature is above its operating temperature range.	Use the battery within its operating temperature range.
Cannot charge.	Is the power plug of the battery charger securely connected?	Remove and reconnect the power plug of the battery charger, and then charge again. If it still does not charge, contact the place of purchase.
	Is the charging plug of the battery charger securely inserted into the battery?	Remove and reconnect the charging plug of the battery charger, and then charge again. If it still does not charge, contact the place of purchase.
	Are the charging adapter and charging plug or charging adapter and battery charging port securely connected?	Securely connect the charging adapter and charging plug or charging adapter and battery charging port, and charge again. If it still does not charge, contact the place of purchase.
	Are the connection terminals of the battery charger, charging adapter, or battery dirty?	Clean the connection terminals with a clean rag or cotton bud dampened with ethanol, etc. and then charge again. If it still does not charge, contact the place of purchase.
The battery does not charge even when the battery charger is connected.	The battery may have reached the end of its life.	Replace the battery with a new one.
The battery and battery charger become hot.	The temperature of the battery and battery charger may exceed the operating temperature.	Stop charging, and wait a while before starting to charge again. The surface temperature may exceed 60°C due to the surrounding environment, depending on the model. There is a problem if the battery and battery charger case deform or remain hot for a while after charging. Contact the place of purchase.
The battery charger is hot.	The battery charger may become hotter than normal when charging multiple batteries in succession.	Wait a while between charges.







Symptoms	Causes/possibilities	Remedies
The battery charger LED does not light up.	Is the charging plug of the battery charger securely inserted into the battery?	Check whether any foreign material is attached to the connection area, and remove and reconnect the charging plug. If the problem is not resolved, contact the place of purchase.
	Is the battery fully charged?	The LED turns off when the battery is fully charged, but this is normal. Remove and reconnect the power plug of the battery charger, and then charge again. If the LED still does not light up, contact the place of purchase.
The battery cannot be removed.		Contact the place of purchase.
The battery cannot be inserted.		Contact the place of purchase.
Liquid is leaking from the battery.		Stop use immediately and contact the place of purchase.
An abnormal smell is emitted.		Stop use immediately, and contact the place of purchase.
Smoke is emitted.		Stop use immediately and contact the place of purchase.
The cycle computer does not start.	Is the battery charging?	When charging with the battery installed to a bicycle, you cannot turn the cycle computer ON. Stop charging. The power automatically turns OFF if charging is started while the cycle computer is running.
	If the cycle computer does not start when the power button is pressed, the charge of the built-in battery of the cycle computer may be low.	The built-in battery of the cycle computer needs to be charged. Refer to "Power ON/OFF."
The key does not turn.	Foreign material such as dirt or dust may be stuck in the battery or battery mount.	Turn the key while pushing the battery in the installation direction. If the battery is removed, follow the cleaning procedure to clean it. If the battery is not removed or cleaning does not solve the problem, contact the place of purchase.
The battery rattles.	Are the battery and battery mount installed in the correct position? Is the installation part of the battery and battery mount deformed?	Contact the place of purchase.
The LED light does not light up at all after pressing the satellite system on/off switch.	Has it been left unused for an extended period of time?	The built-in battery of the satellite system on/off switch needs to be charged. Refer to "Power ON/OFF."
	There is a risk that the battery's temperature is above its operating temperature range.	Turn the power ON after leaving the battery for a little while in a temperature range where discharge is possible. If the LED still does not light up, contact the place of purchase.



Symptoms	Causes/possibilities	Remedies
The screen of the cycle computer or the LED of the satellite system on/off switch turns on for a short period of time when the satellite system on/off switch is pressed, but the power cannot be turned ON.	Is the (main) battery level too low?	Charge the (main) battery.
	Is the (main) battery properly connected?	Check that the (main) battery is securely connected. If the power still does not turn ON, contact the place of purchase.
	The level of the built-in battery of the satellite system on/off switch is too low.	The built-in battery of the satellite system on/off switch needs to be charged. Refer to "Power ON/OFF."

## ■ Battery LED lamp error indication





System errors and equivalent warnings are displayed with various light up patterns of the battery LED lamp

### When there are five battery LED lamps

Lighting pattern*1	Indication conditions	Recovery
	Battery overcurrent protection occurred.	If it occurs during charging, remove and reconnect the charging plug. If the situation does not improve, have your place of purchase perform the following. <ul style="list-style-type: none"> <li>Connect a genuine SHIMANO battery. Also check the power cord for abnormalities. If the error persists, contact your distributor.</li> </ul>
	If the temperature exceeds the guaranteed operating range, the battery output is turned off.	If the temperature is higher than the temperature at which discharging is possible, leave the battery in a cool location with no direct sunlight until the internal temperature of the battery has decreased sufficiently. If the temperature is lower than the temperature at which discharging is possible, leave the battery indoors until the internal temperature has increased to an appropriate temperature.
	Battery does not recognize the drive unit.	If it occurs during charging, remove and reconnect the charging plug. If the situation does not improve, have your place of purchase perform the following. <ul style="list-style-type: none"> <li>Connect a genuine SHIMANO battery. Also check the power cord for abnormalities. If the error persists, contact your distributor.</li> </ul>
	This is displayed if an error occurs during charging.	Remove the battery charger from the battery and press the power switch. If an error is displayed, contact the place of purchase.
	Electrical abnormality in battery detected.	Remove the battery charger after connecting it to the battery. Make sure to press the power switch with the battery connected. If an error is displayed for the battery alone, have your place of purchase perform the following. <ul style="list-style-type: none"> <li>Connect a genuine SHIMANO battery. Also check the power cord for abnormalities. If the error persists, contact your distributor.</li> </ul>

\*1  : Off  : Lights up  : Flashes

## When there is one battery LED lamp

Lighting pattern*1	Indication conditions	Recovery	Error code*2
 (Repeatedly flashes 5 times)	Electrical abnormality in battery detected.	Remove the battery charger after connecting it to the battery. Make sure to press the power switch with the battery connected. If an error is displayed for the battery alone or E023 is displayed on the cycle computer, have your place of purchase perform the following. <ul style="list-style-type: none"> <li>• Connect a genuine SHIMANO battery. Also check the power cord for abnormalities. If the error persists, contact your distributor.</li> </ul>	E023
 (Repeatedly flashes 4 times)	Battery overcurrent protection occurred.	Have your place of purchase perform the following. <ul style="list-style-type: none"> <li>• Connect a genuine SHIMANO battery. Also check the power cord for abnormalities. If the error persists, contact your distributor.</li> </ul>	E024
	This is displayed if an error occurs during charging.	Remove the battery charger from the battery and press the power switch. If an error is displayed, contact the place of purchase.	No display
 (Repeatedly flashes 3 times)	If the temperature exceeds the guaranteed operating range, the battery output is turned off.	If the temperature is higher than the temperature at which discharging is possible, leave the battery in a cool location with no direct sunlight until the internal temperature of the battery has decreased sufficiently. If the temperature is lower than the temperature at which discharging is possible, leave the battery indoors until the internal temperature has increased to an appropriate temperature.	W200 (W020)
 (Repeatedly flashes 1 time)	Battery does not recognize the drive unit.	Have your place of purchase perform the following. <ul style="list-style-type: none"> <li>• Connect a genuine SHIMANO battery. Also check the power cord for abnormalities. If the error persists, contact your distributor.</li> </ul>	E025

\*1 : Flashing

\*2 Displayed on the cycle computer.  
The lighting pattern displayed in parentheses may be displayed, depending on the drive unit that is connected.

# SHIMANO

## **SHIMANO NORTH AMERICA BICYCLE, INC.**

One Holland, Irvine, California 92618, U.S.A. Phone: +1-949-951-5003

## **SHIMANO EUROPE B.V.**

High Tech Campus 92, 5656 AG Eindhoven, The Netherlands Phone: +31-402-612222

## **SHIMANO INC.**

3-77 Oimatsu-cho, Sakai-ku, Sakai City, Osaka 590-8577, Japan

Please note: specifications are subject to change for improvement without notice. (English)

© Mar. 2020 by SHIMANO INC. ITP